

TT 22-A II

ACTIVE HIGH OUTPUT TWO-WAY SPEAKER

DESCRIPTION

TT22-A II is a 2-way active system featuring a 12" neodymium woofer, 86 mm voice coil in a bass reflex configuration and a 1.4" exit, 75 mm voice coil neo compression driver. An extremely careful acoustic design plus the highest quality transducers and a powerful amplifier make the TT22-A II speaker system the perfect solution from live sound situations to playback and monitoring. The amplifier section features 1100 watt power – 800 watt low frequency, 300 watt high frequency. The cabinet is made of marine Baltic birch plywood and features high-resistance polyurea coating. The cabinets has 2 side handles, 6 x fly-track rigging points, quick lock pin receptacles and a steel pole mount.



FEATURES

- 1100 W Class D Amplifier
- 90 x 60 constant directivity coverage angle
- 12" neo woofer, 3.5" mm voice coil
- 1.5" neo c. driver, 3.0" mm voice coil
- DSP Processing
- Onboard RDNet Control
- Multifunctional cabinet
- Very high output

TECHNICAL SPECIFICATIONS

Acoustical specifications	Frequency Response:	50 Hz ÷ 20000 Hz
	Max SPL @ 1m:	131 dB
	Horizontal coverage angle:	90°
	Vertical coverage angle:	60°
Transducers	Compression Driver:	1 x 1.5" neo, 3.0" v.c
	Woofers:	12" neo, 3.5" v.c
Input/Output section	Input signal:	bal/unbal
	Input connectors:	XLR, RDNet Ethercon
	Output connectors:	XLR, RDNet Ethercon
	Input sensitivity:	-2 dBu/+4 dBu
Processor section	Crossover Frequencies:	800 Hz
	Protections:	Thermal, HF
	Limiter:	Fast Limiter
	Controls:	proces., 8 sel. presets
	RDNet:	Yes
Power section	Total Power:	2200 W Peak, 1100 W RMS
	High frequencies:	600 W Peak, 300 W RMS
	Low frequencies:	1600 W Peak, 800 W RMS
	Cooling:	Convection
	Connections:	Powercon IN/OUT
Physical specifications	Cabinet/Case Material:	Baltic birch plywood
	Hardware:	6 x fly tracks, quick lock, pole mount
	Handles:	2 on side
	Pole mount/Cap:	Yes
	Grille:	Steel
	Color:	Black
Size	Height:	600 mm / 23.62 inches
	Width:	365 mm / 14.37 inches
	Depth:	379 mm / 14.92 inches
	Weight:	22.6 kg / 49.82 lbs
Shipping informations	Package Height:	655 mm / 25.79 inches
	Package Width:	410 mm / 16.14 inches
	Package Depth:	420 mm / 16.54 inches
	Package Weight:	25.5 kg / 56.22 lbs



PART NUMBER

- **13000445**

TT 22-A II

115V

EAN 8024530013219

- **13000444**

TT 22-A II

220-240V



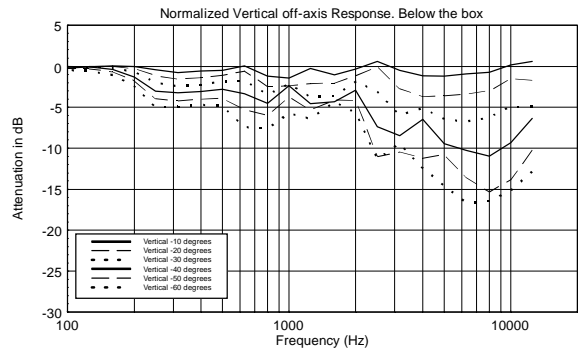
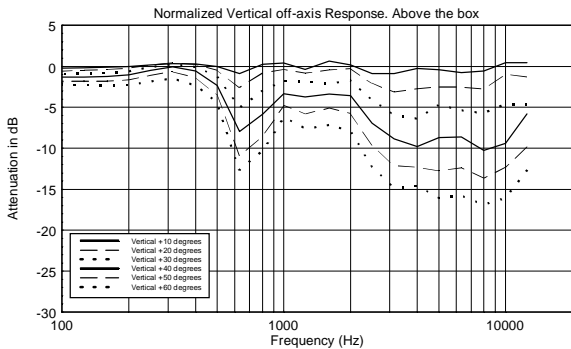
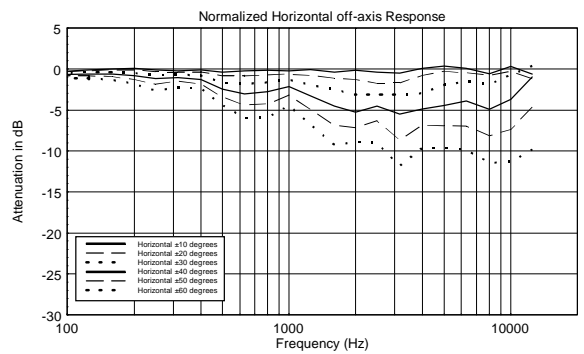
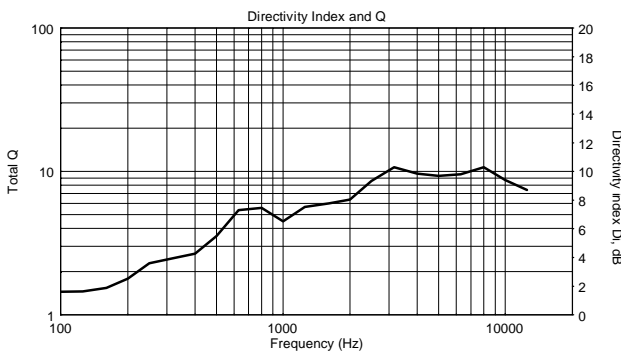
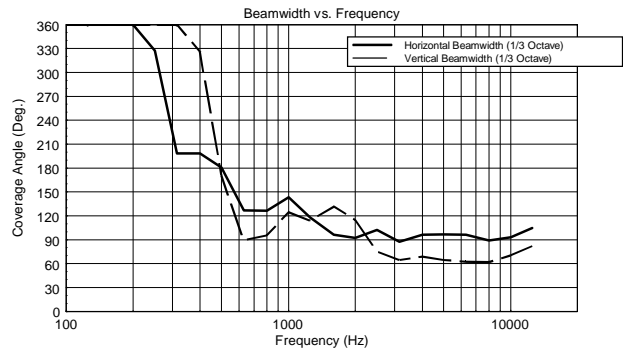
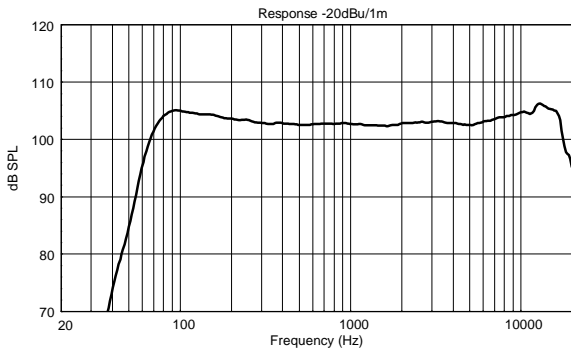

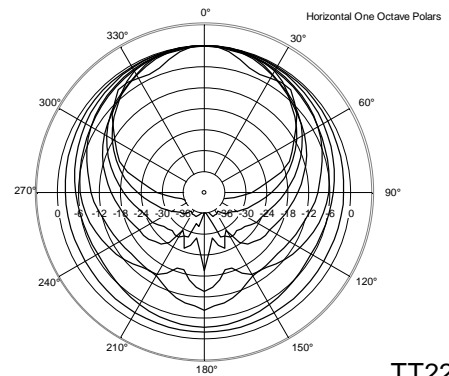
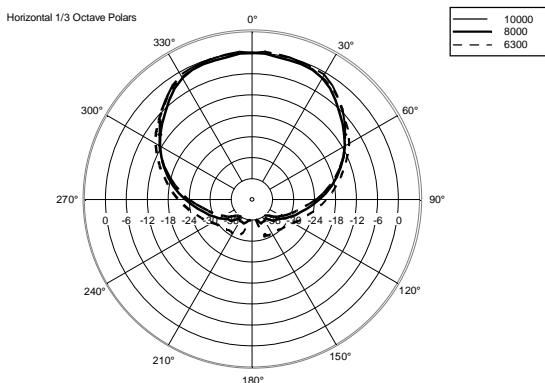
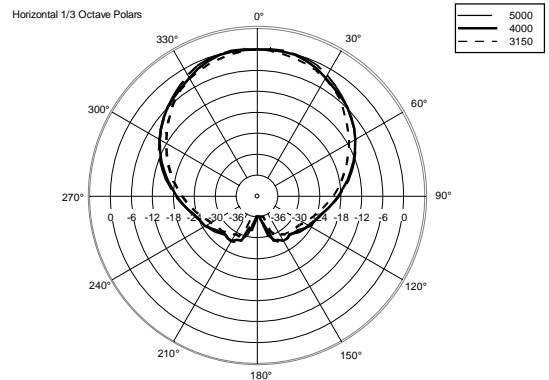
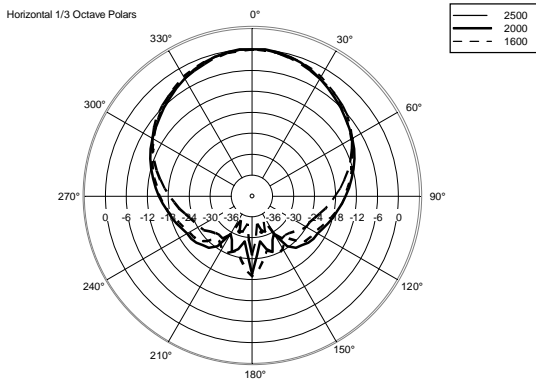
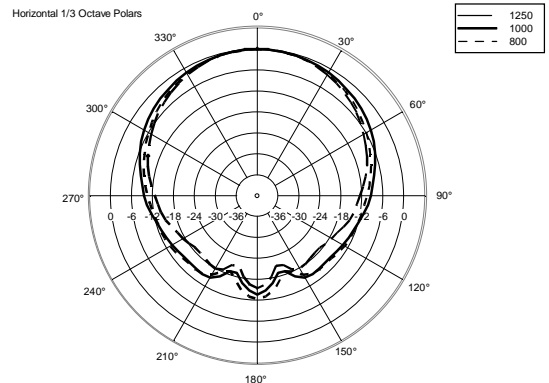
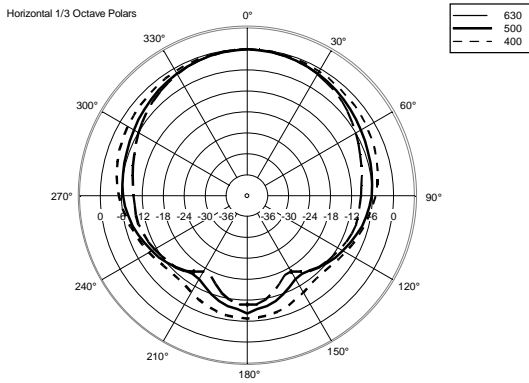
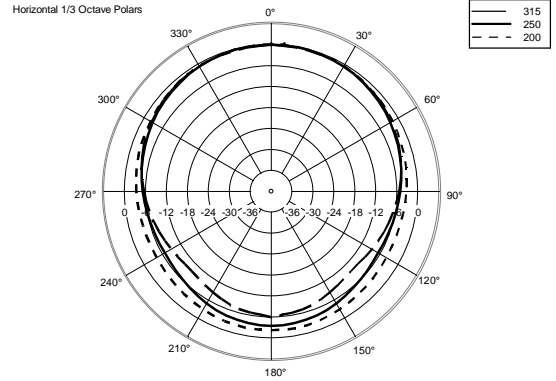
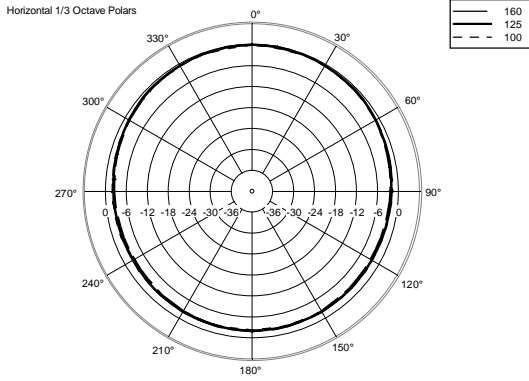

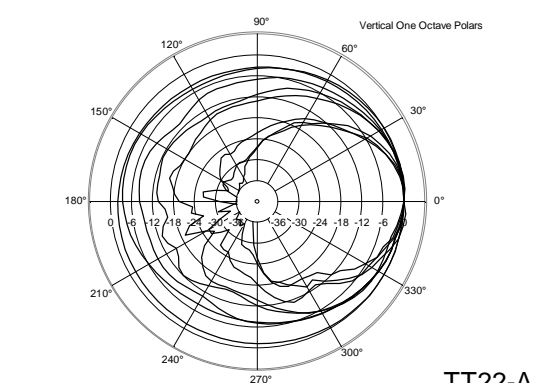
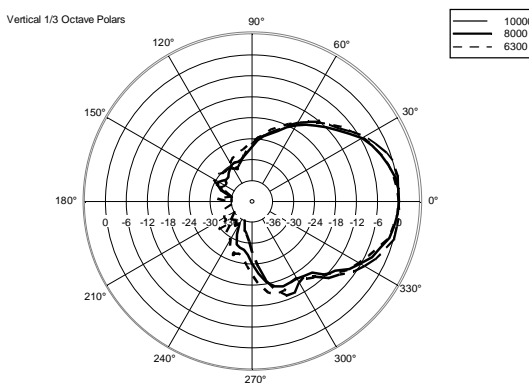
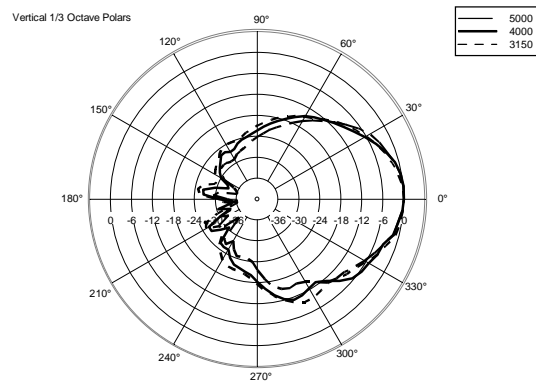
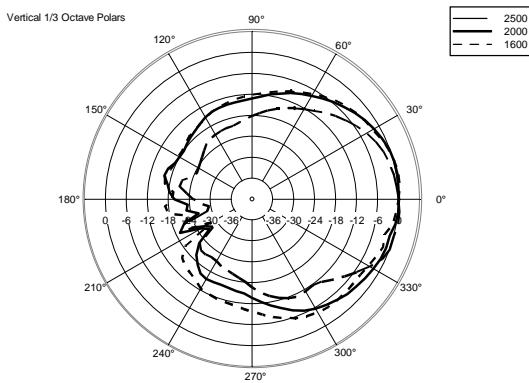
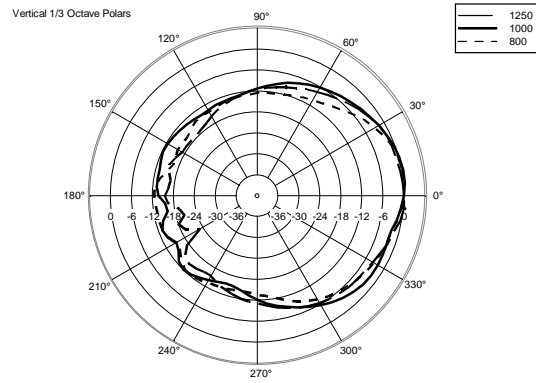
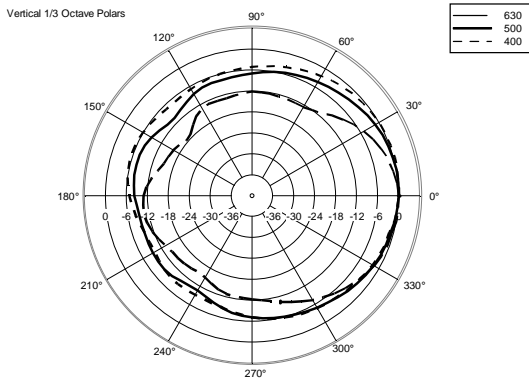
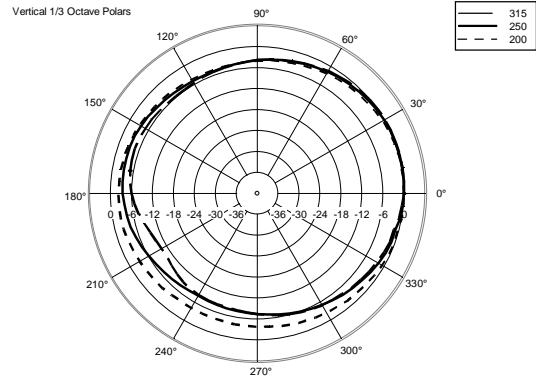
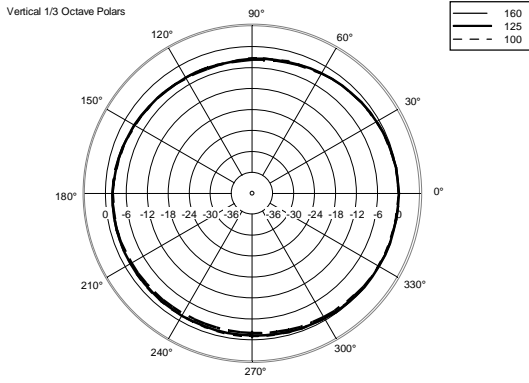

EAN 8024530012991







ACCESSORIES

	AC PM-M20	PART NUMBER EAN:	13360067 8024530014599
	AC PMX POLE MOUNT M20	PART NUMBER EAN:	13360232 8024530010058
	AC PRO-FS PROFESS. LOCKING FLOOR STAND	PART NUMBER EAN:	13360109 8024530006471
	AC PRO-PM PROFESS. LOCKING POLE MOUNT	PART NUMBER EAN:	13360110 8024530006488
	CABLES KIT CBL ETHERCON 0.7M	PART NUMBER EAN:	12399016 8024530013844
	CABLES KIT CBL ETHERCON 1.5M	PART NUMBER EAN:	12399017 8024530013851
	CABLES KIT CBL ETHERCON 3M	PART NUMBER EAN:	12399035 8024530013868
	CABLES KIT CBL ETHERCON 5M	PART NUMBER EAN:	12399018 8024530013875
	CABLES KIT CBL ETHERCON TO XLR F 0.2M	PART NUMBER EAN:	12399019 8024530013882



CABLES KIT CBL ETHERCON TO XLR M 0.2M

PART NUMBER **12399020**
EAN: 8024530013899



COVER CVR TT 22 II

PART NUMBER **13360325**
EAN: 8024530013424



DOUBLE STUD 4X

PART NUMBER **13360030**
EAN: 8024530020231



VERTICAL BRACKET V-BR TT 22 II

PART NUMBER **13360328**
EAN: 8024530013332